





Assembly Instruction

Item NO.STE-500#

NO	Description	Sketch	Q'TY
A	Connector bolt		2PCS
B	Connector cap		2PCS
C	Touch up Pen		1PCS
D	Wire lid		1PCS



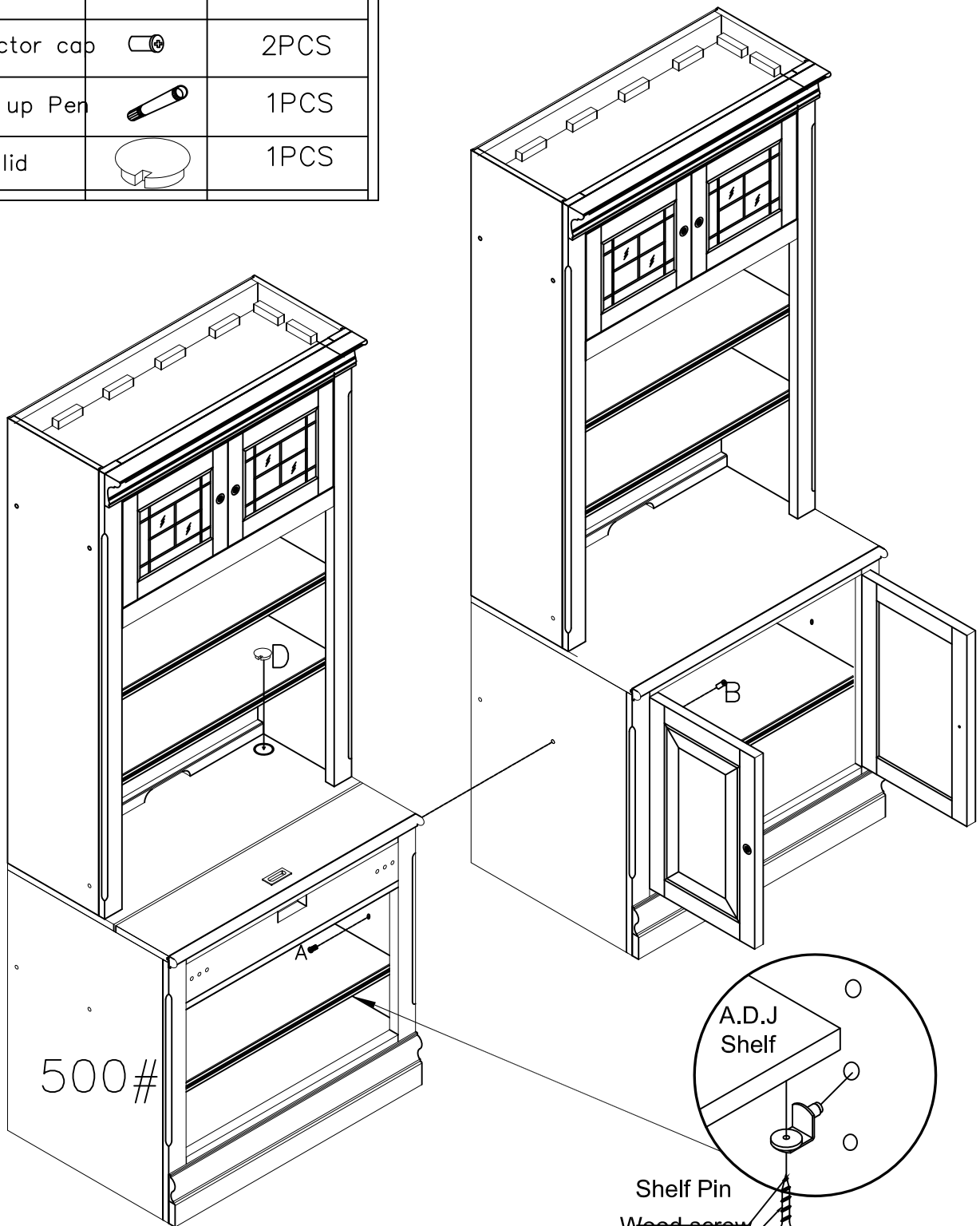

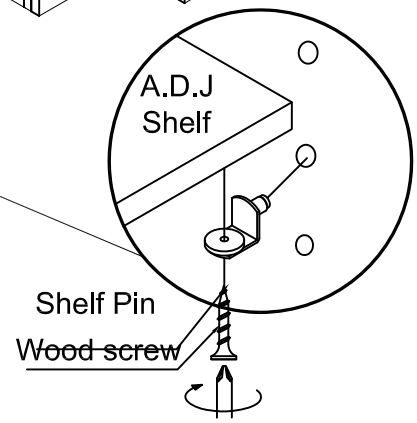

500#

THE SHELVES ARE
DETACHABLE, THE CONSUMER
CAN FREELY ADJUST THE
SHELF SPACING.



Assembly Instruction

Item NO.STE-510#



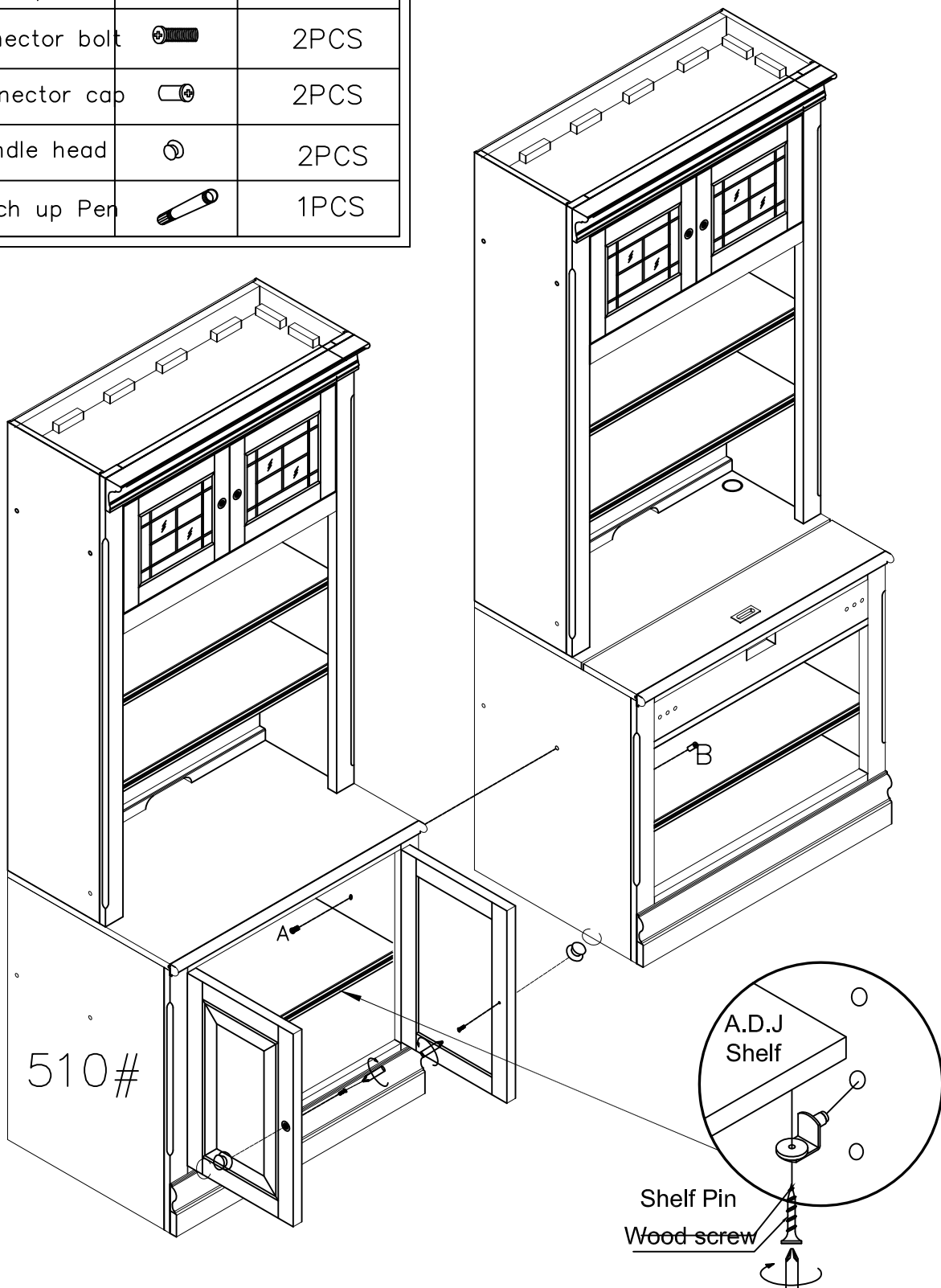

NO	Description	Sketch	Q'TY
A	Connector bolt		2PCS
B	Connector cap		2PCS
C	Handle head		2PCS
D	Touch up Pen		1PCS



THE SHELVES ARE
DETACHABLE, THE CONSUMER
CAN FREELY ADJUST THE
SHELF SPACING

Assembly Instruction

Item NO.STE-520#



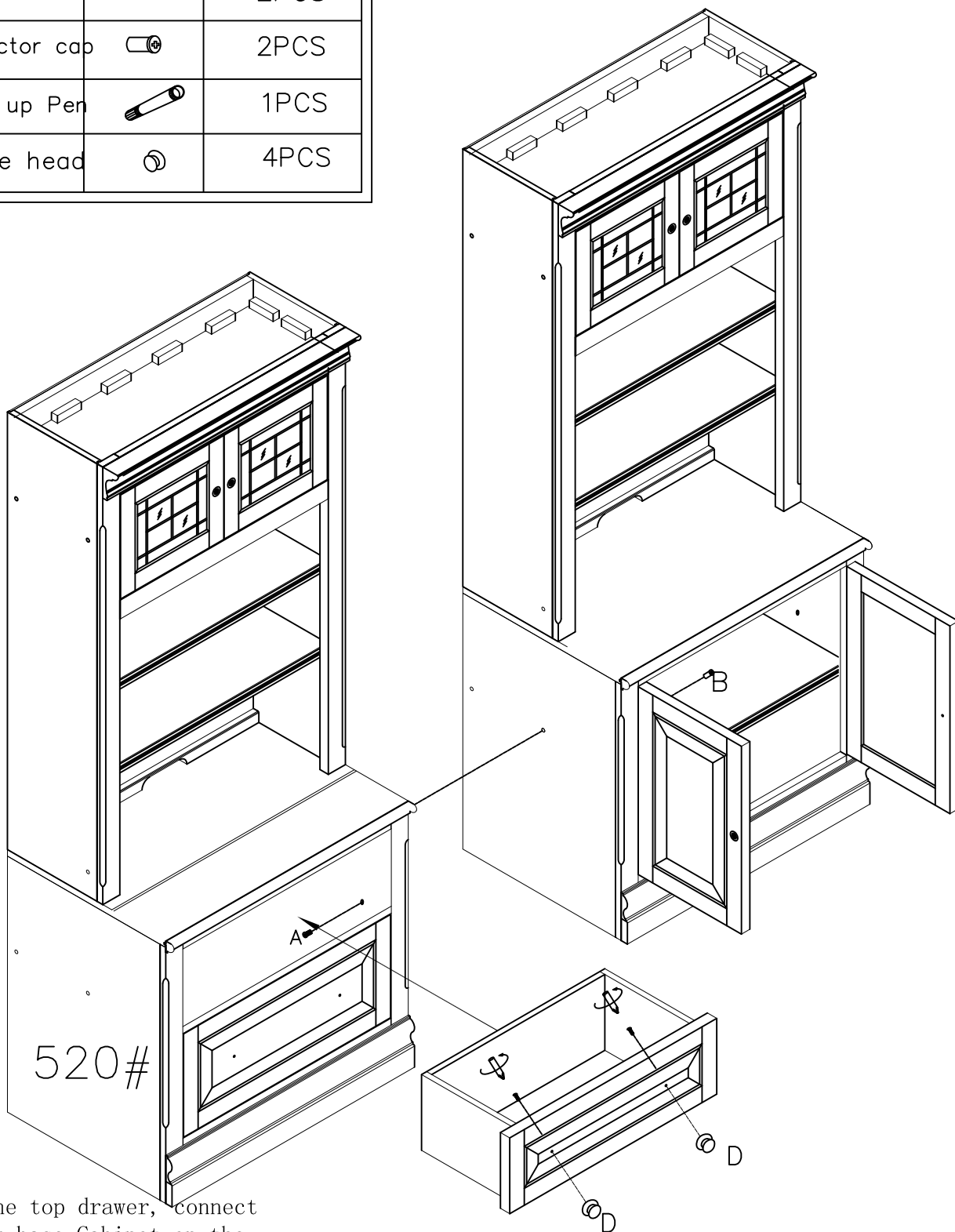



NO	Description	Sketch	Q'TY
A	Connector bolt		2PCS
B	Connector cap		2PCS
C	Touch up Pen		1PCS
D	Handle head		4PCS



Detach the top drawer, connect the other base Cabinet on the side panels, then put the drawer back.

Assembly Instruction

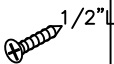

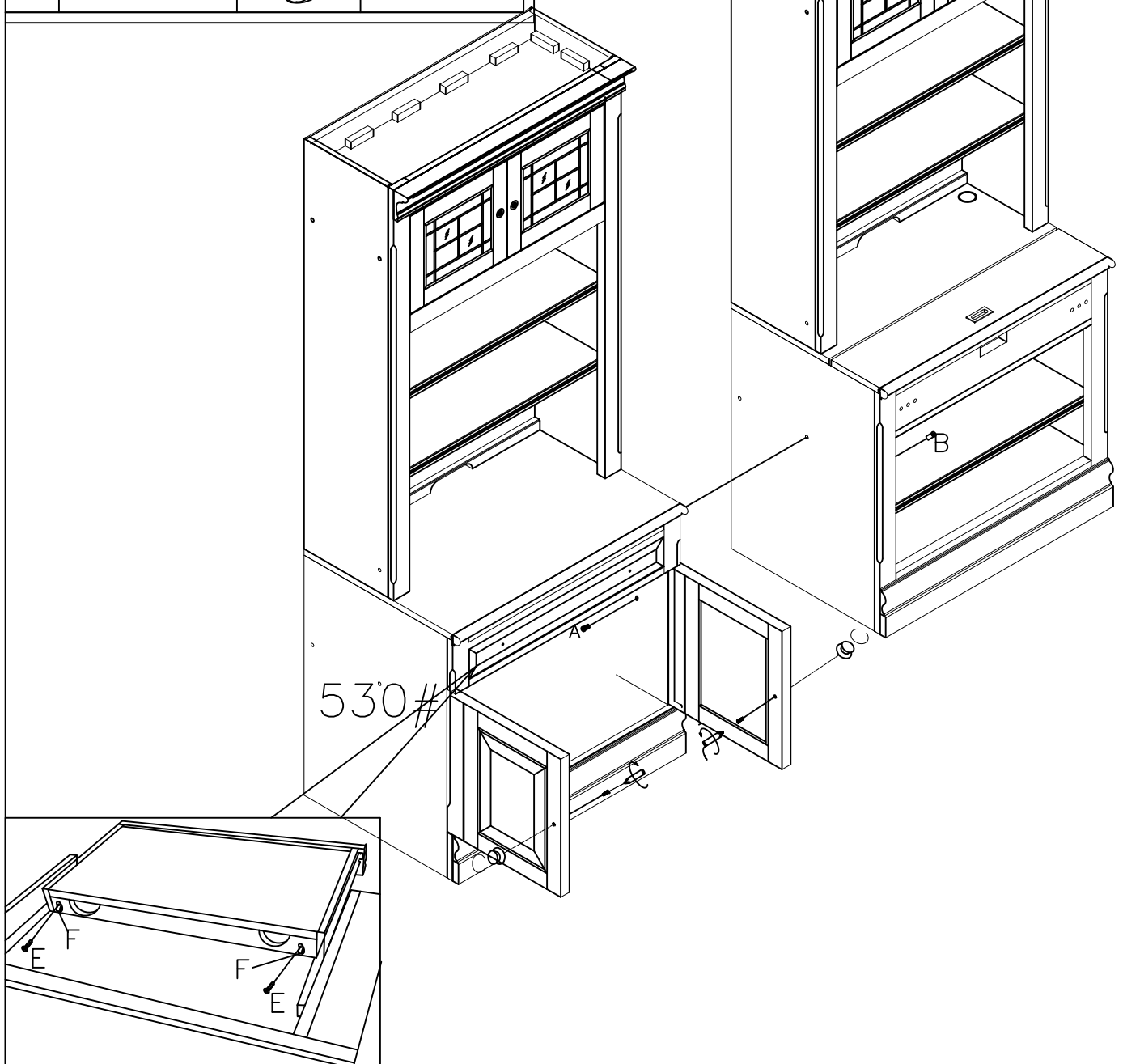

Item NO.STE-530#

NO	Description	Sketch	Q'TY
A	Connector bolt		2PCS
B	Connector cap		2PCS
C	Handle head		4PCS
D	Touch up Pen		1PCS
E	Screw		6pcs
F	Wire buckle		6pcs



Assembly Instruction

Item NO.STE-550#

NO	Description	Sketch	Q'TY
A	Connector bolt		3PCS
B	Connector cap		3PCS
C	Handle head		2PCS
D	Screw	 5/8" L	2PCS

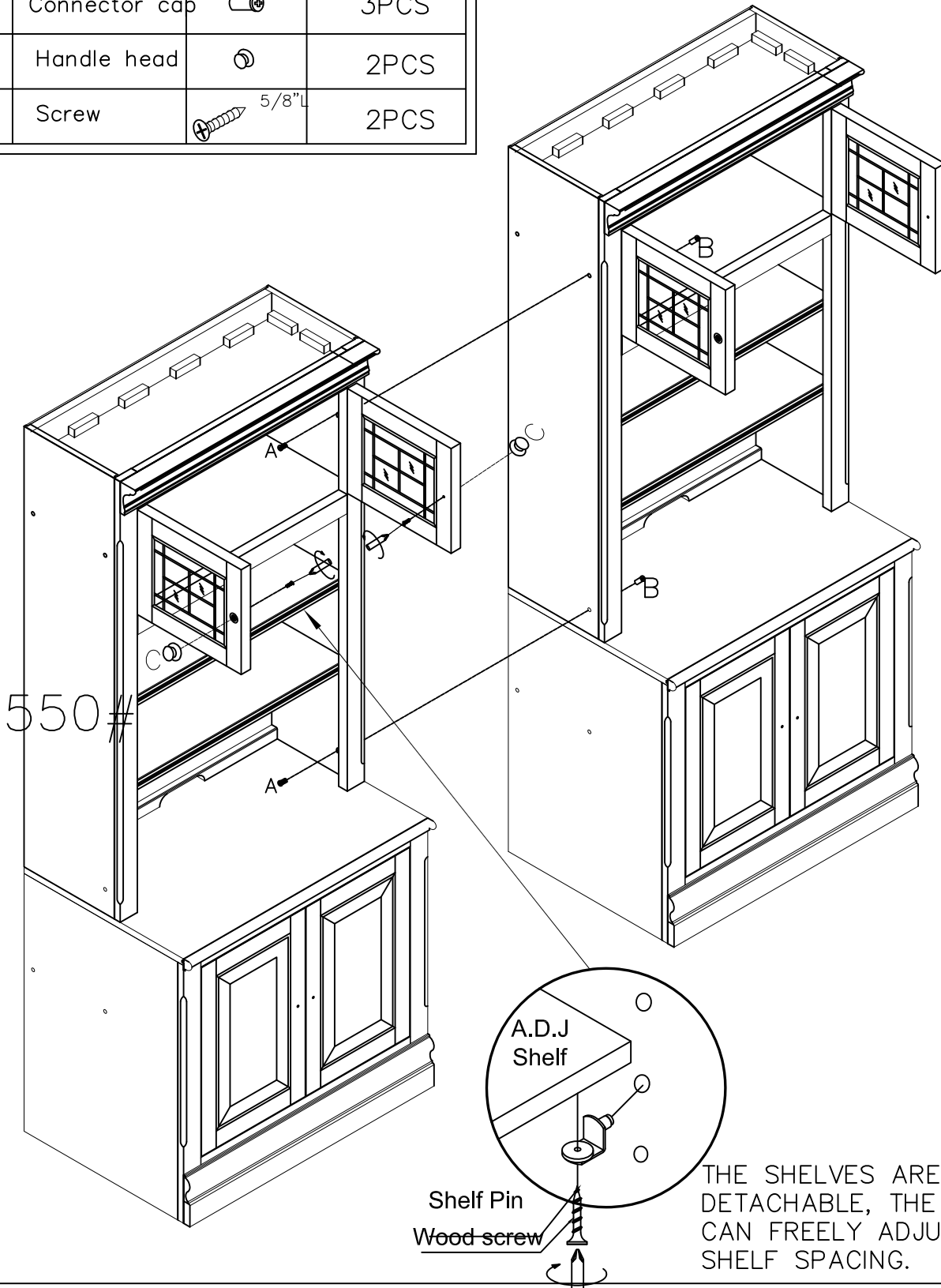

THE SHELVES ARE DETACHABLE, THE CONSUMER CAN FREELY ADJUST THE SHELF SPACING.

Assembly Instruction

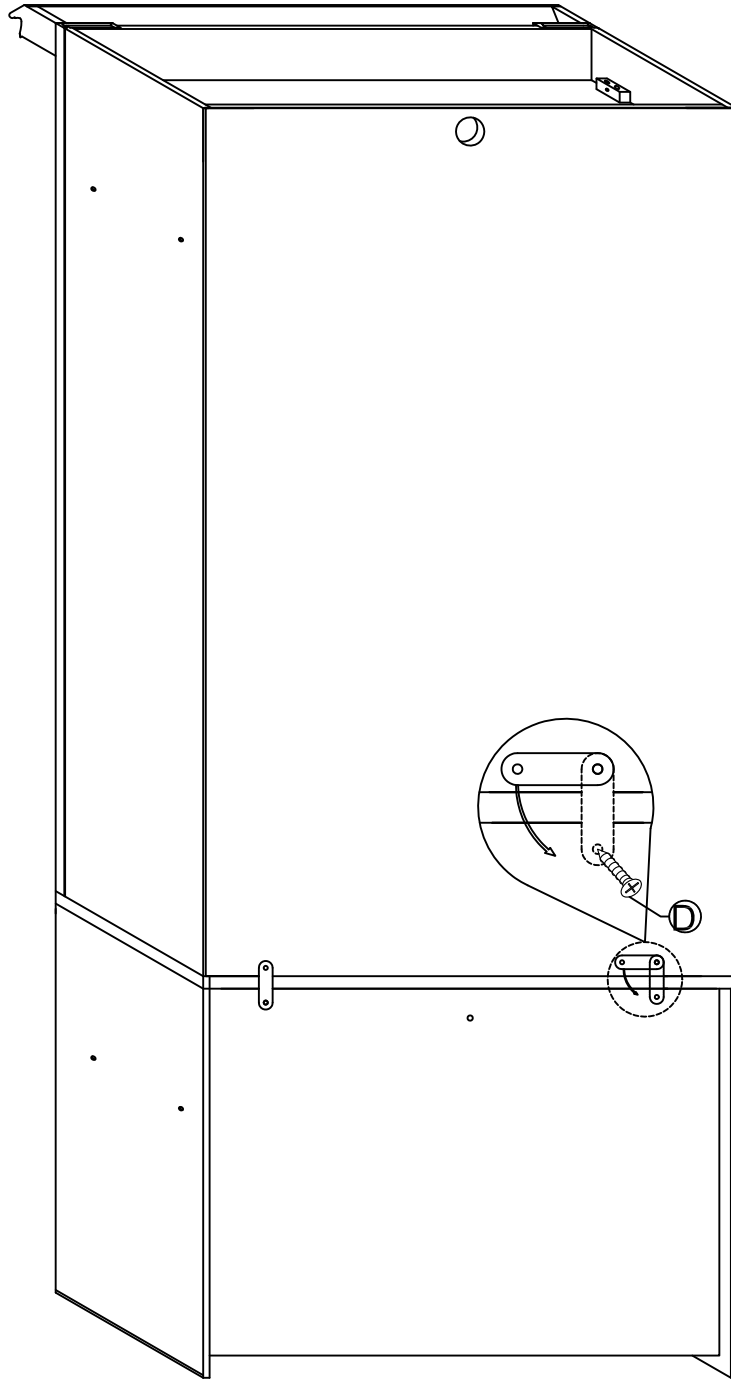

Use Screw(D) to assemble the Hutch to the Desk.

Assembly Instruction

Item No. STE-505#

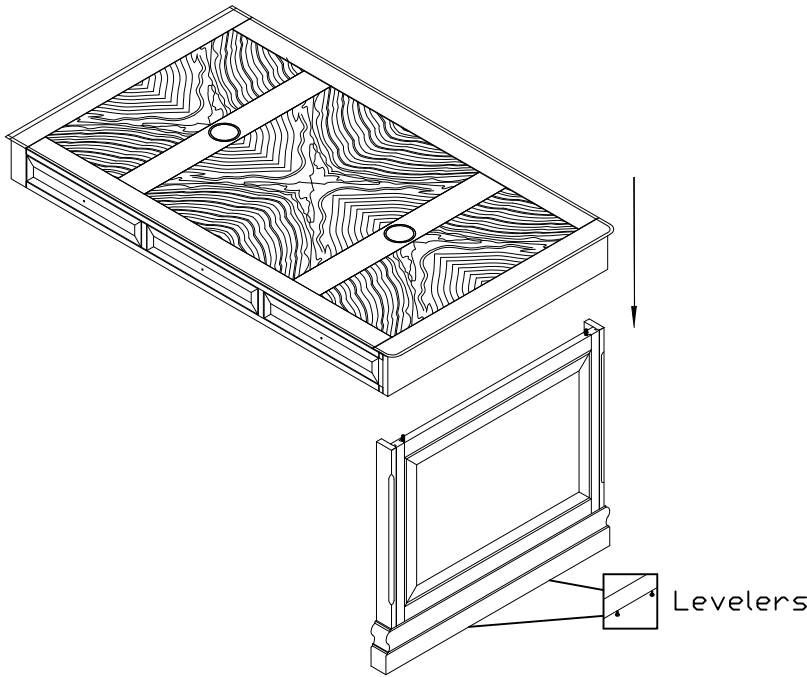

No	Description	Sketch	Q'TY
A	Bolt		3pcs
B	Flat washer		3pcs
C	Allen Wrench		1pcs
D	Lock washer		3pcs
E	Pencil		1pcs
F	Screw		8pcs
G	Wire buckle		8pcs
H	Bolt		2pcs
I	Flat washer		2pcs
J	Allen Wrench		1pcs
K	Lock washer		2pcs
L	Wire lid		2pcs
M	Handle head		6PCS

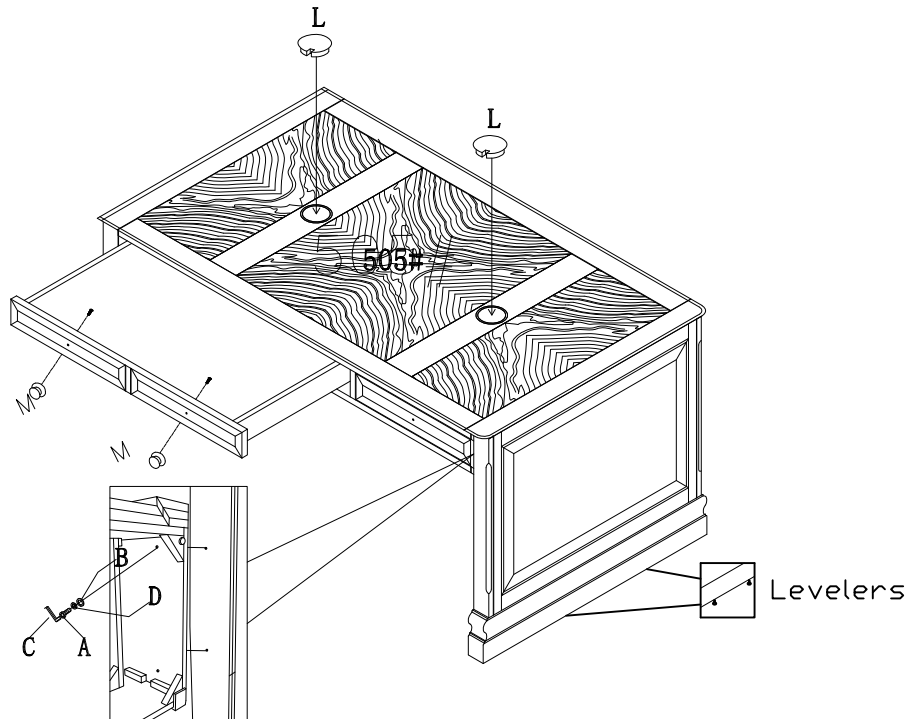

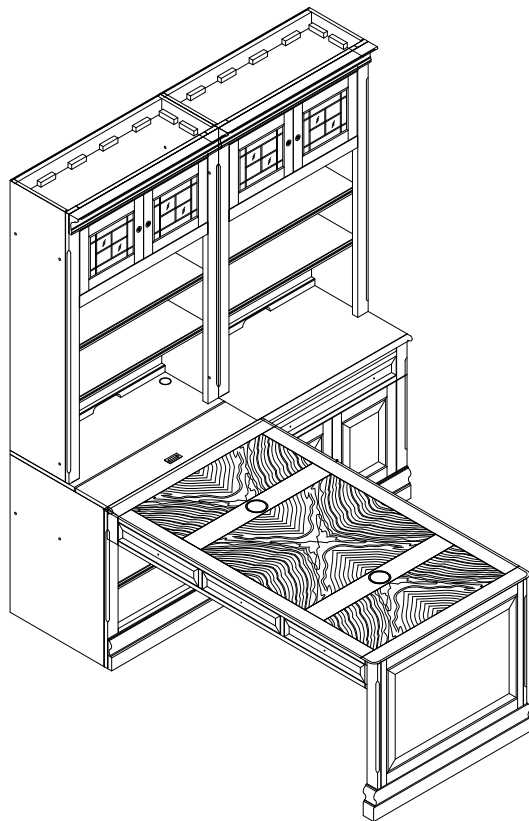
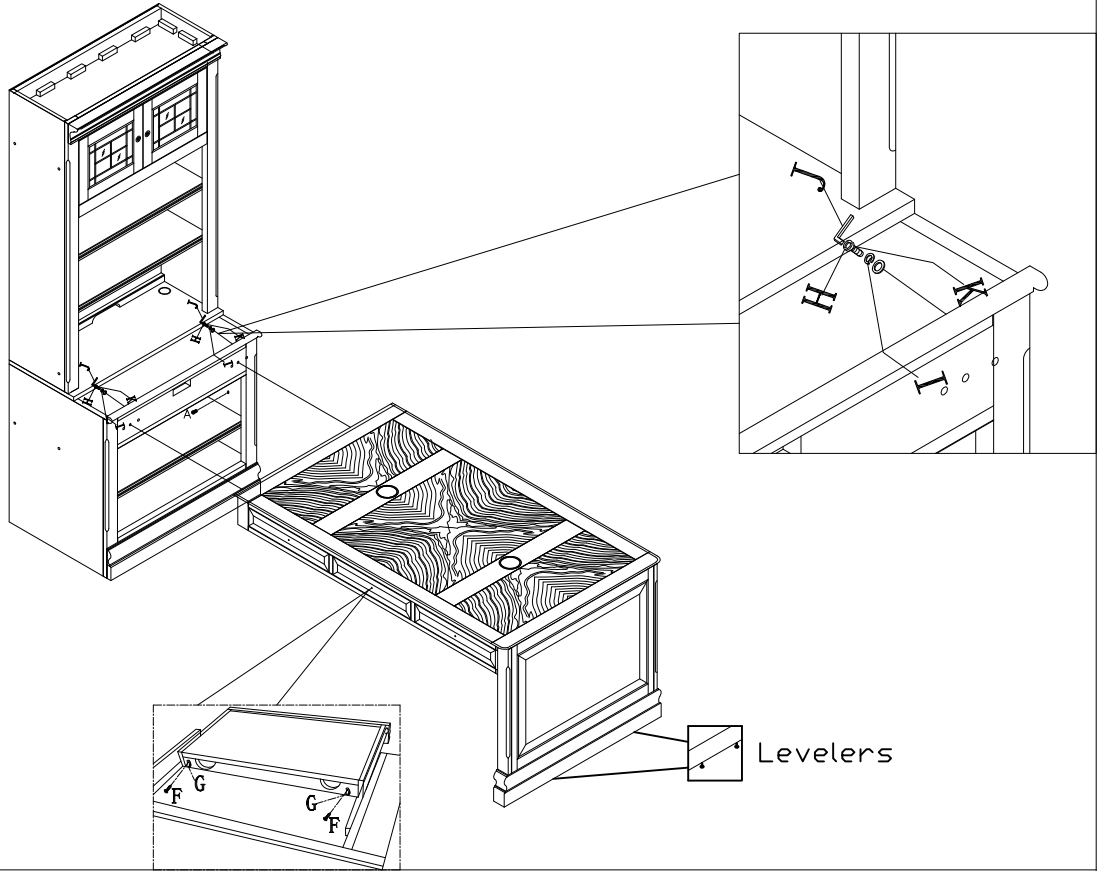

Assembly Instruction

Item No. STE-505#



Assembly Instruction

Item NO.STE-575#

NO	Description	Sketch	Q'TY
A	Touch up Pen		1PCS
B	Handle head		2PCS

